

SHB6110



www.philips.com/welcome

GB Bluetooth stereo headset

PHILIPS

Table of contents

1	Important	3	8	Using more of your Bluetooth stereo headset	13
1.1	Hearing safety	3	8.1	Learn about the battery status	13
1.2	Electric-, Magnetic- and Electromagnetic Fields (“EMF”)	3	8.2	Learn about simultaneous use for voice and audio	13
1.3	General maintenance	4	8.3	Learn about FullSound	13
1.4	Disposal of your old product	4			
1.5	Remove the integrated battery	4			
1.6	Notice for the European Union	5	9	Technical data	14
1.7	Trademarks	5	10	Frequently asked questions	15
2	What’s in the box	6			
3	What else you’ll need	6			
4	What you can do with your headset	6			
5	Overview of your Bluetooth stereo headset	7			
6	Get started	8			
6.1	Charge your headset	8			
6.2	Pair your headset with your mobile phone	8			
7	Using your Bluetooth stereo headset	10			
7.1	Connecting to your mobile phone	10			
7.2	Automatic power saving	10			
7.3	Operating your headset	10			
7.4	Wearing your Bluetooth stereo headset	12			

1 Important

1.1 Hearing safety

Danger

To avoid hearing damage limit the time you use the headphones at high volume and set the volume to a safe level. The louder the volume the shorter is the safe listening time.

Be sure to observe the following guidelines when using your headphones.

- Listen at reasonable volumes for reasonable periods of time.
- Be careful not to adjust the volume continuously upwards as your hearing adapts.
- Do not turn up the volume so high that you can't hear what's around you.
- You should use caution or temporarily discontinue use in potentially hazardous situations.
- Using this headset with both ears covered while driving is not recommended and may be illegal in some areas while driving.
- For your safety avoid distractions from music or phone calls while in traffic or other potentially dangerous environments.
- Excessive sound pressure from earphones and headphones can cause hearing loss.

1.2 Electric-, Magnetic- and Electromagnetic Fields (“EMF”)

- 1 Philips Electronics manufactures and sells many products targeted at consumers, which, like any electronic apparatus, in general have the ability to emit and receive electromagnetic signals.
- 2 One of Philips leading Business Principles is to take all necessary health and safety measures for our products, to comply with all applicable legal requirements and to stay well within the EMF standards applicable at the time of producing the products.
- 3 Philips is committed to develop, produce and market products that cause no adverse health effects.
- 4 Philips confirms that if its products are handled properly for their intended use, they are safe to use according to scientific evidence available today.
- 5 Philips plays an active role in the development of international EMF and safety standards, enabling Philips to anticipate further developments in standardization for early integration in its products.

1.3 General maintenance

To avoid damage or malfunction:

- Do not expose the headset to excessive heat.
- Do not drop your headset.
- Do not allow your headset to be submerged in water.
- Do not use any cleaning agents containing alcohol, ammonia, benzene, or abrasives.

If cleaning is required use a soft cloth, if necessary dampened with a minimum amount of water or diluted mild soap, to clean the product.

About operating and storage temperatures

- Do not operate or store in a place where temperature is below -15°C (5°F) or above 55°C (131°F) as this may shorten your battery life.

1.4 Disposal of your old product



Your product is designed and manufactured with high quality materials and components, which can be recycled and reused.

When this crossed-out wheeled bin symbol is attached to a product, it means the product is covered by the European Directive 2002/96/EC. Please be informed about the local separate collection system for electrical and electronic products.

Please act according to your local rules and do not dispose of your old product with your normal household waste. The correct disposal of your old product will help prevent potential negative consequences to the environment and human health.

1.5 Remove the integrated battery

If in your country there is no collection / recycling system for electronic products you can protect the environment by removing and recycling the battery before disposing the headset. Please take the battery to a battery collection and recycling location.

Removing the battery will destroy the product.

Make sure the headset is disconnected from the USB charging cable before removing the battery.

You can remove the battery by completing the following steps.

- 1** Tear off the ear cushion of the left earshell.
- 2** Remove the screws that hold the earshell in place.
- 3** Open the housing.
- 4** Cut the battery wires.
- 5** Remove the battery.

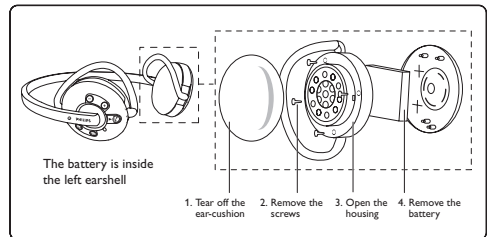

1.6 Notice for the European Union



Hereby, Philips Consumer Lifestyle, BU Accessories, declares that this Philips Bluetooth headset SHB6110 is in compliance with the essential requirements and other relevant provisions of Directive 1999/5/EC.



ECD AMB544 9056 -
SHB6110.pdf
Adobe Acrobat

1.7 Trademarks

Trademarks are the property of Koninklijke Philips Electronics N.V. or their respective owners. The Bluetooth word mark and logos are owned by the Bluetooth SIG, Inc. and any use of such marks by Koninklijke Philips Electronics N.V. is under license.

2 What's in the box:

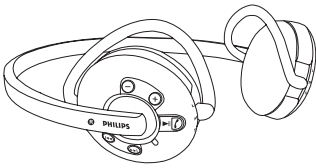

Bluetooth headset

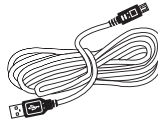

USB charging cable

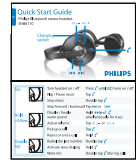

Quick Start Guide

3 What else you'll need:

A mobile phone that is capable of Bluetooth stereo streaming, i.e. that is compatible with the Bluetooth A2DP profile.

Other devices (Notebooks, PDA's, Bluetooth adapters, MP3 players etc.) are also compatible if they share the Bluetooth profiles supported by the headset. These profiles are:

For wireless handsfree communication:

- The Bluetooth headset profile (HSP) or the Bluetooth Handsfree profile (HFP).

For wireless stereo listening:

- The Bluetooth Advanced Audio Distribution profile (A2DP).

For wireless music control:

- The Bluetooth Audio Video Remote Control profile (AVRCP).

The headset features Bluetooth Version 2.0, but will also work with devices featuring other Bluetooth versions that support the profiles above.

4 What you can do with your headset

With your Philips headset you can:

- Lead wireless hands-free conversations
- Wirelessly listen to music
- Wirelessly control music
- Switch between calls and music

5 Overview of your Bluetooth stereo headset

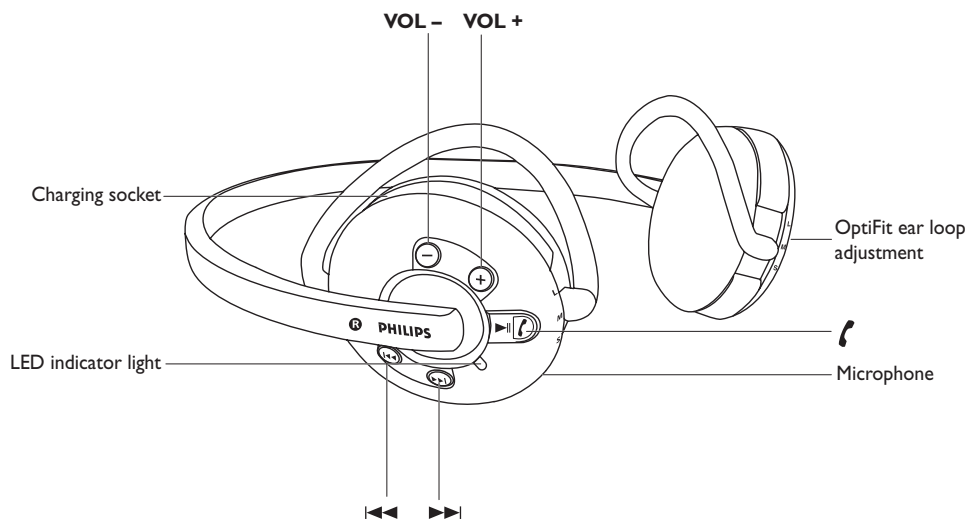

6 Get started

6.1 Charge your headset

Before you use your headset for the first time, charge the battery for 6 hours for optimum battery capacity and lifetime.

Warning

Use only the original USB charging cable. Using another charger may damage or destroy your headset.

Plug the USB charging cable into your computer's USB socket and connect the charger cable to the headset's charging socket.

Caution

Finish your call before charging the headset, as connecting the headset for charging will cut an ongoing call.

During recharging the LED indicator will show a red light. The LED will turn off once charging is complete. Typically a full charge will take 3.5 hours. You can operate the headset during charging.

Tip

You can save energy and protect the environment by unplugging the charger after charging is complete.

6.2 Pair your headset with your mobile phone

Your Bluetooth stereo headset must be paired to your mobile phone before connecting and using it for the first time with your phone. "Pairing" will establish a unique encrypted link between your mobile phone and your headset.

Pairing has to be done

- before using your headset with your mobile phone for the very first time, or
- after pairing more than two Bluetooth devices with your headset. Your headset can store up to two paired devices in its memory, if you pair more than two devices the oldest paired device is overwritten.
- "Pairing" is different from "connecting" as pairing typically only has to be done once, whereas the phone and headset need to "connect" every time one of the two devices was turned off or out of range.

To pair your headset with your mobile phone

Make sure the headset is charged, your mobile phone is turned on and its Bluetooth feature is enabled. Check your phones user guide to learn how to turn on Bluetooth on your phone.

- 1 With the headset turned off, press  until the LED starts blinking red and blue alternately. The headset will remain in “pairing mode” for 5 minutes.
- 2 Pairing typically involves a few simple steps outlined below, please check your phones user guide for details.



- 3 Access a menu on your mobile phone typically called “Setup”, “Settings”, “Bluetooth” or “Connectivity”. Select the option to discover or search for Bluetooth devices. After a few seconds your phone should indicate that it has found the “Philips SHB6110”.
- 4 Upon selecting the “Philips SHB6110” on your mobile phone typically you will need to confirm the pairing and enter a passcode. Please enter the headsets passcode “0000” (four zeros).

After successful pairing, the headset will connect to the mobile phone. You will hear a long beep to confirm successful pairing and the headsets LED will change from flashing red/blue to periodically flashing blue every three seconds.

7 Using your Bluetooth stereo headset

7.1 Connecting to your mobile phone

Turn on the headset by pressing  until the LED lights up. Once turned on the headset will re-connect automatically to the last device it was connected with. If the last connected device is not available the headset tries to reconnect to the penultimate device that was connected to the headset.

If you turn the mobile phone or its Bluetooth feature on **after** turning on the headset connect the headset from your mobile phones Bluetooth menu.

7.2 Automatic power saving

If your headset cannot find any Bluetooth device to connect to in range within five minutes it will automatically power down to save battery life.

7.3 Operating your headset

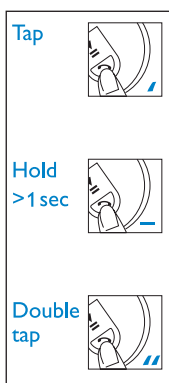

To control the headset you tap, hold and double tap the headset's buttons. A "tap", "hold" and "double tap" differs in the duration and speed of the button press.

The table below shows how to operate your headset:

In order to:	Do this:	Sound and LED indicator feedback
Enter pairing mode	Press Ⓛ until the LED starts blinking red / blue alternately	Alternating red/blue flash
Turn headset on	Press Ⓛ for 2 seconds	<ul style="list-style-type: none"> • 3x red flash: battery is low. • 2x red flash: > 25% of charge remaining. • 1x blue flash: > 50% of charge remaining.
Turn headset off	Hold Ⓛ for min. 4 sec	One long beep
Play / Pause music	Tap Ⓛ	
Stop music	Tap ▶▶ and ◀◀ simultaneously	
Skip Fwd/Bwd	Tap ▶▶ or ◀◀	
FullSound on / off	Hold Ⓛ and ▶▶ simultaneously for 4 sec.	One short beep: On Two short beeps: Off
Adjust volume	Tap VOL- or VOL+	
Pick up a call / End a call	Tap Ⓛ	
Pick up a 2 nd call / put other call on hold / switch back*	Tap Ⓛ	
Reject a call	Hold Ⓛ	One long beep
Redial the last number	Double tap Ⓛ	Two short beeps
Activate voice dialing*	Hold Ⓛ until “beep” sound	One short beep
Mute Mic	Double tap Ⓛ (during call)	Short beep every five seconds until mute is turned off.
Transfer call to phone*	Hold ▶▶	One short beep

Other status indicators:

Connected to Bluetooth device (while in standby or while listening to music)	Blue light flashes every 3 seconds.
Ready for pairing	In pairing mode, LED flashes continuously alternating red and blue.
On but not connected	Blue light flashing fast
In call	While call is ringing, blue light flashes fast (twice per second). After call pick up, slows down to once per second.
Low battery	LED will flash red instead of blue. A short double beep will be heard every minute with five minutes or less of talk time remaining.

* Available if supported by your mobile phone

7.4 Wearing your Bluetooth stereo headset

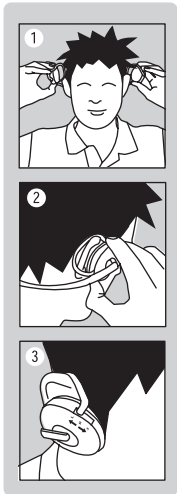

The OptiFit neckband features an ergonomically optimized hinge, carefully placed in the center of the ear shell for optimum wearing comfort. This optimized fit also results in ideal sound performance due to perfect speaker placement over your ear canal.

To personalize the fit of your headset set the ear loops to the largest position marked with “L”. Pick up the headset with both hands with the microphone facing forward and lower the headset on your ears. While wearing the headset personalize the fit by moving the ear loop adjustment markers up and down to the position optimal for you.

8 Using more of your Bluetooth stereo headset

8.1 Learn about the battery status

Immediately after turning the headset on, the LED will indicate the battery status.

LED behaviour	Battery status
3x red blinking	Less than 25% battery remaining
2x red blinking	Less than 50% of charge remaining
1x blue blinking	50% or more of charge remaining

The LED will continuously flash red with about 5 minutes of talk time remaining. You will also hear two short beeps every minute to remind you to end the call or transfer it to your phone before the battery runs out.

8.2 Learn about simultaneous use for voice and audio

Your Bluetooth stereo headset can connect to

- one Bluetooth audio device (supporting the A2DP and AVRCP Bluetooth profile) and
- one Bluetooth communication device (supporting HFP or HSP Bluetooth profile) at the same time.

Therefore you can connect your Bluetooth stereo headset.



- with a Bluetooth stereo enabled phone to both listen to music and lead calls, or
- with a Bluetooth phone that does not support Bluetooth stereo (A2DP) to lead calls and at the same time to a Bluetooth audio device (Bluetooth enabled MP3 player, Bluetooth audio adapter etc.) to listen to music. Make sure to pair the phone first with your Bluetooth headset, then turn both the phone and headset off to then pair the Bluetooth audio device.

With the SwitchStream feature you can listen to music and monitor your calls at the same time. Even while listening to music, you will hear a ring tone when receiving a call and can switch to the call simply by tapping the  button.

8.3 Learn about FullSound

FullSound is a smart digital sound enhancement algorithm, which runs on a powerful processor inside your Bluetooth headset.

It restores and enhances bass, treble, stereo effects and dynamics of compressed music and leads to a more natural, “real life” sound experience based on years of acoustic research and tuning.

The FullSound feature decreases music playing time by less than 10% if activated. The feature is activated when you buy the product, to turn FullSound off or on hold  and  simultaneously for 4 seconds. You will hear one short beep after turning FullSound on, and two short beeps after turning FullSound off.

9 Technical data

- Up to 14 hours of playtime or talk time
- Up to 300 hours of standby time
- Typical time for a full charge: 3.5 hours
- Rechargeable Lithium-Polymer battery (360mAh)
- Bluetooth 2.0+EDR, Bluetooth stereo support (A2DP – Advanced Audio Distribution Profile, AVRCP – Audio Video Remote Control Profile), Bluetooth mono support (HSP – Headset Profile, HFP – Hands-Free Profile)
- FullSound digital sound enhancement
- OptiFit ergonomic design
- Operating range up to 10 meters (33 feet)

Specifications are subject to change without notice.

10 Frequently asked questions

Bluetooth headset does not switch on.

Battery is very low.

Charge your Bluetooth headset.

No connection to mobile phone.

Bluetooth disabled.

Enable Bluetooth on your mobile phone and turn the headset on after turning on the phone.

Mobile phone cannot find headset

- **The headset may be connected to another previously paired device**
Turn the currently connected device off or move it out of range.
 - **Pairings may have been reset or headset has been previously paired with other device.**
Start the pairing process as described in this user manual.
-

Redialing does not work.

Your mobile phone may not support this feature.

Voice dialing does not work.

Your mobile phone may not support this feature.

The headset is connected to a Bluetooth stereo enabled phone, but music will play on the phone's speaker only.

Phone may have option to listen to music via speaker or headset.

Check your phones user guide on how to transfer the music to the headset.

Audio quality when streaming from phone is very low or audio streaming does not work at all.

Phone may not be A2DP compatible and only support (mono) HSP/HFP.

Check your phones compatibility.

Audio quality is poor and crackling noises can be heard.

Bluetooth audio source is out of range.

Reduce the distance between the headset and the Bluetooth audio source, or remove obstacles between them.

I hear but cannot control the music on my device (e.g. skip forward / backward).

Bluetooth audio source does not support AVRCP.

Check the user manual of your audio source.

The headset is not charging or charging very slowly when using the USB charging cable.

The USB port provides no or too little power.
Your USB port should provide 500mA. Try another USB port at the back of your PC or a powered USB hub.

Please visit www.philips.com/welcome for additional support.



Philips Consumer Lifestyle

AQ95-56F-998KR/2ndF

2008

(Report No. / Numéro du Rapport)

(Year in which the CE mark is affixed / Année au cours de laquelle le marquage CE a été apposé)

EC DECLARATION OF CONFORMITY

(DECLARATION DE CONFORMITE CE)

We / Nous, PHILIPS CONSUMER LIFESTYLE B.V.

(Name / Nom de l'entreprise)

TUSSENDIEPEN 4, 9206 AD DRACHTEN, THE NETHERLANDS

(address / adresse)

Declare under our responsibility that the electrical product(s):

(Déclarons sous notre propre responsabilité que le(s) produit(s) électrique(s):)

PHILIPS

SHB6110/00, /05, /10

(brand name, nom de la marque)

(Type version or model, référence ou modèle)

Bluetooth Headset

(product description, description du produit)

To which this declaration relates is in conformity with the following harmonized standards:

(Auquel cette déclaration se rapporte, est conforme aux normes harmonisées suivantes)

(title, number and date of issue of the standard / titre, numéro et date de parution de la norme)

EN 60950-1:2001+A11:2004

EN 301 328 V1.7.1: 2006

EN 301 489-1 V1.8.1: 2008

EN 301 489-17 V1.3.2: 2008

EN 50360:2002

EN 62301:2005

Following the provisions of :

(Conformément aux exigences essentielles et autres dispositions pertinentes de :)

1999/5/EC (R&TTE Directive) (Directive R&TTE 1999/5/CE)

2009/125/EC (EuP Directive)

- EC/1275/2008

- EC/278/2009

And are produced under a quality scheme at least in conformity with ISO 9001 or CENELEC Permanent Documents

(Et sont fabriqués conformément à une qualité au moins conforme à la norme ISO 9001 ou aux Documents Permanents CENELEC)

The Notified Body N.A. performed N.A.
(L'Organisme Notifié) (Name and number/ nom et numéro) (a effectué) (description of intervention / description de l'intervention)

And issued the certificate, N.A.
(et a délivré le certificat) (certificate number / numéro du certificat)

Remarks:

(Remarques:)

Drachten, The Netherlands
10/12/2009

(place, date / lieu, date)

A.Speelman, Compliance Manager

(signature, name and function / signature, nom et fo

